

# GC4K-E *Ver1.0*

## ***Auto Start Genset Control & Protection Module for Electronic J1939 Engine***



**KUTAI ELECTRONICS INDUSTRY CO., LTD.**

TEL : +886-7-8121771

FAX : +886-7-8121775

Website : [www.kutai.com.tw](http://www.kutai.com.tw)

Headquarters : No.3, Ln. 201, Qianfu St., Qianzhen Dist., Kaohsiung City 80664, Taiwan

ISO 9001  
**ETC**

---

## TABLE OF CONTENTS

<b>Section</b>	<b>Page</b>
<b>SECTION 1 : SAFETY PRECAUTIONS</b>	
<b>SECTION 2 : OVERVIEW OF GCU-4K SYSTEM COMPONENTS</b>	
2.1 Package Contents.....	5
2.2 Overview of GC4K-D07 External Features.....	6
2.3 GC4K-E External Features .....	7
<b>SECTION 3 : PRODUCT INSTALLATION</b>	
3.1 Panel Cut-Out and Installation Drawing .....	8
3.1.1 GC4K-D07 .....	8
3.1.2 GC4K-E Controller Dimensions.....	8
3.1.3 Wiring Installation Precautions .....	9
3.2 Controller Connections With Display Unit.....	9
3.2.1 USB Connector Attachment Instructions.....	10
3.2.2 RJ45 Connector Attachment Instructions.....	10
3.3 Generator Connections With GC4K-E Controller .....	11
3.3.1 GC4K-E Connection Terminal Numbers and Locations Drawing .....	11
3.3.2 GC4K-E Connection Terminals, Communication Ports, and Connectors .....	12
3.3.3 Recommended Wiring Diagram .....	14
<b>SECTION 4 : SYSTEM PARAMETERS SETTINGS</b>	
4.1 Explanation Of Terms and Icons Used With GC4K-E .....	15
4.2 Precautions .....	15
4.3 Open Owner Functions Screen .....	16
4.3.1 Onsite and Remote Parameters Setting.....	16
4.4 Language Setting.....	16
4.5 System Settings.....	16
4.5.1 Voltage Parameters Settings.....	17
4.5.1.1 Phase.....	17
4.5.1.2 Nominal Voltage Setting .....	17
4.5.1.3 Over Voltage Protection Setting .....	18
4.5.1.4 Under Voltage Protection Settings .....	18
4.5.1.5 Voltage Readings Calibration .....	18
4.5.2 Current Parameters Settings.....	18
4.5.2.1 Current Transformer (CT) Setting .....	18
4.5.2.2 Over Current Protection Settings .....	18
4.5.2.3 Current Readings Calibration .....	19
4.5.3 Frequency Parameters Settings.....	19
4.5.3.1 Nominal Frequency Setting .....	19
4.5.3.2 Over Speed Protection Settings .....	19
4.5.3.3 Under Speed Protection Settings .....	19
4.5.4 Fuel Level Parameter Setting.....	19
4.5.4.1 Fuel Level Sender Settings .....	19
4.5.4.2 Low Fuel Level Response Settings .....	19

---

4.5.5	User Defined Input and Output Settings.....	20
4.5.5.1	User Defined Input-A and User Defined Input-B Settings .....	20
4.5.5.2	User Defined Output-A and User Defined Output-B Settings .....	20
4.5.6	Engine Start / Stop Setting .....	20
4.5.6.1	Engine Start Settings.....	20
4.5.6.2	Engine Idle Timer .....	20
4.5.6.3	Engine Cool Down Timer.....	20
4.5.7	Battery and Charge Alternator Settings.....	21
4.5.7.1	Battery Voltage Warning Setting .....	21
4.5.7.2	Charge Alternator Protection Settings.....	21
4.5.8	Location Service .....	21
4.5.9	Service Maintenance Reminder .....	21
4.5.10	Voice and Audio Alarm Settings.....	22
4.5.10.1	Audio Alarm Setting.....	22
4.5.10.2	Voice Warning Setting .....	22
4.5.10.3	User Recorded Engine Start Voice Warning .....	22
4.5.10.3.1	Record Engine Start Voice Warning .....	22
4.5.10.3.2	Engine Start Voice Warning Download Procedure .....	23
4.5.11	Communication Module Settings.....	23
4.5.12	Factory Setting Recovery .....	23
4.5.13	Security Alert Settings .....	24
4.5.14	Erase Event Log, Reset Running Hours or KWH meter to zero .....	24
4.6	About This Unit .....	24
4.7	WIFI Settings .....	24
4.8	Time and Date Settings .....	24
4.9	Replicate Settings .....	24
4.9.1	Settings Transfer Procedure on Master GC4K-E Device.....	24
4.9.2	Operations on Receiving Devices .....	24

## **SECTION 5 : UNIT OPERATIONAL TESTS**

5.1	Mode Selector.....	25
5.2	Display Pages .....	26
5.2.1	Home Page.....	26
5.2.2	Electrical Power Readings.....	27
5.2.3	SAE J1939 Data Page.....	27
5.2.4	Event Log Page .....	28
5.2.5	Voltage Level / Current Level Recorder Screen.....	28
5.2.6	Location Map Page.....	29
5.3	Initial Operation (MANU and AUTO).....	29
5.3.1	Items to Check.....	29
5.3.2	Start Procedure .....	29
5.3.3	Shut Down Procedure .....	29
5.3.4	AUTO Mode Initial Operation Test .....	29

---

## SECTION 6 : REMOTE OPERATION

6.1 Overview of Remote Monitoring and Control Functions .....	30
6.1.1 Three Options for GC4K-E Internet Connection.....	30
6.2 Controller Connection to Kutai Server .....	31
6.2.1 Wi-Fi Connection Settings .....	31
6.2.2 Dynamic IP Connection (Ethernet) .....	31
6.2.3 3G / 4G Wireless Router Installatio .....	32
6.3 Mobile Connection to GCU-4K .....	32
6.3.1 GenOnCall® APP Download.....	33
6.3.2 Create a Personal Account on The Kutai Server .....	33
6.3.2.1 Create an Account on The Kutai Website .....	33
6.3.2.2 Create an Account Using The iOS GenOnCall® APP .....	33
6.3.2.3 Create an Account Using The Android GenOnCall® APP .....	33
6.3.3 Bind The Controller and Edit Operator and Viewers .....	34
6.3.4 Establishing Connection With a Controller .....	35
6.3.5 Unbinding a Device .....	35
6.3.6 GenOnCall® Remote : Log-in to Advanced Settings Screen.....	36
6.3.6.1 Push Notification Editor .....	36
6.3.6.2 Overview of Settings Options .....	36
6.3.6.3 Overview of Profile Options .....	36

## SECTION 7 : GCU-4K INTRODUCTION

7.1 Product Overview.....	37
7.2 Features.....	37
7.3 Display Parameter .....	37
7.4 Monitoring and Protections .....	37
7.5 Electrical Characteristics .....	37

## SECTION 8 : SOFTWARE AND FIRMWARE UPDATES

## SECTION 9 : OPTIONAL ACCESSORIES

## SECTION 1 : SAFETY PRECAUTIONS

<b>NOTICE</b>	An essential operation required to ensure that a procedure is done correctly.
<b>CAUTION</b>	A procedure or operation which must be followed exactly or could result in permanent damage to equipment.
<b>WARNING</b>	A procedure or operation that could result in injury to personnel or death if not done correctly.





This manual contains all information necessary for installation, wiring, operation and maintenance of the Kutai GC4K-E Auto Start Genset Control & Protection Module. This manual should be read carefully before operating the system.

<div style="background-color: #ff0000; color: white; display: inline-block; padding: 2px 5px;"><b>WARNING</b></div> <p><b>All installation, wiring, and reference settings of the GC4K-E Control &amp; Protection Module should only be carried out by qualified technical personnel. Improper installation, wiring, or input of reference settings could lead to injury to personnel and/or damage to equipment.</b></p>
---

## SECTION 2 : OVERVIEW OF GCU-4K SYSTEM COMPONENTS

The shipping package should be opened immediately after it is received to check whether or not any collisions have occurred during transport causing external damage and also to confirm that all standard accessories are included in accordance with list 2.1. If there is any external damage apparent or any parts are missing then immediately contact the company you bought the unit from.

### 2.1 Package Contents

 <p>GC4K-D07 Operator display x 1</p>	 <p>DB9 cable (1 meter) x 1</p>	 <p>A-type USB cable (1 meter) x 1</p>
 <p>GC4K-E control unit x 1</p>	 <p>User Manual DVD x 1 disc Display Unit Attachment screws x 1 bag</p>	

## 2.2 Overview of GC4K-D07 External Features (Figure 1)

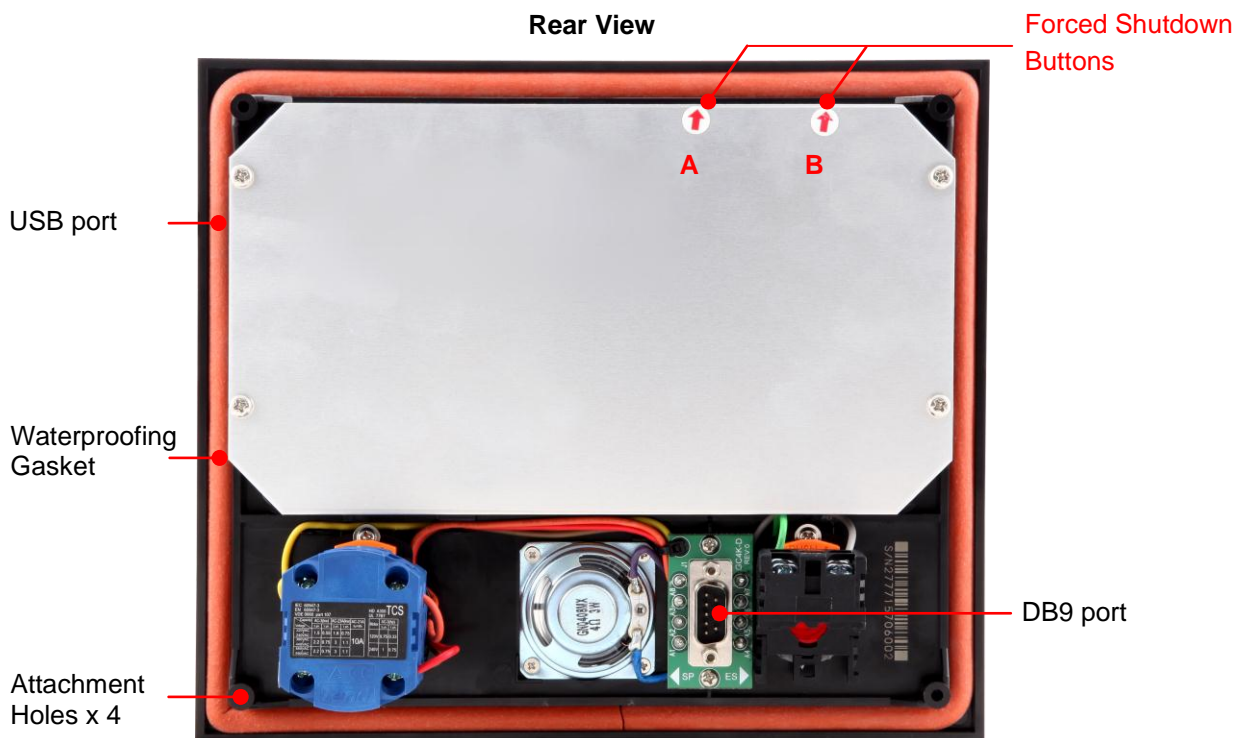

### NOTICE

The Forced Shutdown buttons should only be used if the display unit is not operating normally or the unit cannot be operated by the touch screen. To execute forced shutdown press both A and B buttons at the same time and hold for 15 seconds until the screen turns OFF. Then press the A button to restart the screen display. The system will automatically return to normal operation.

## 2.3 GC4K-E External Features (Figure 2)

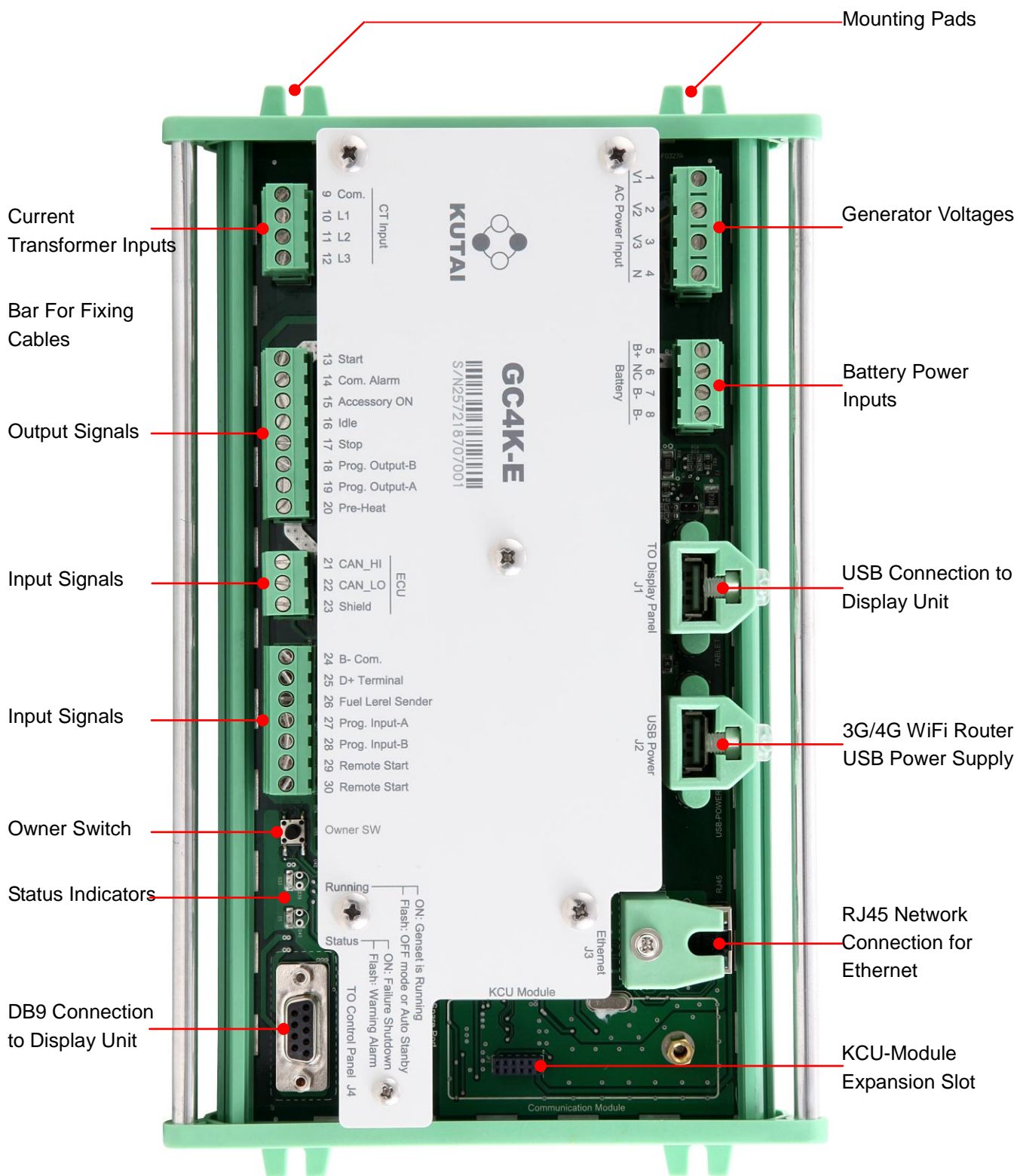



## SECTION 3 : PRODUCT INSTALLATION

### 3.1 Panel Cut-Out and Installation Drawing

#### 3.1.1 GC4K-D07 (Figure 3)

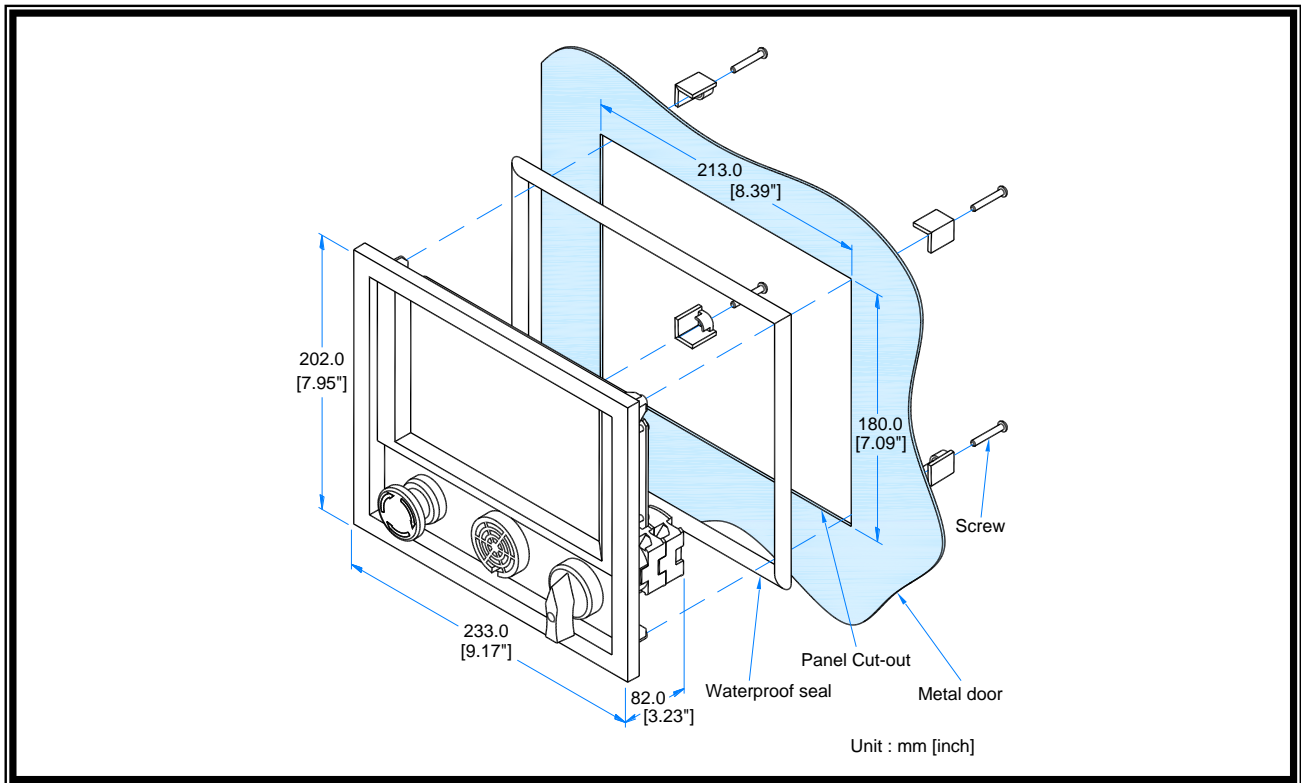

#### 3.1.2 GC4K-E Controller Dimensions (Figure 4)

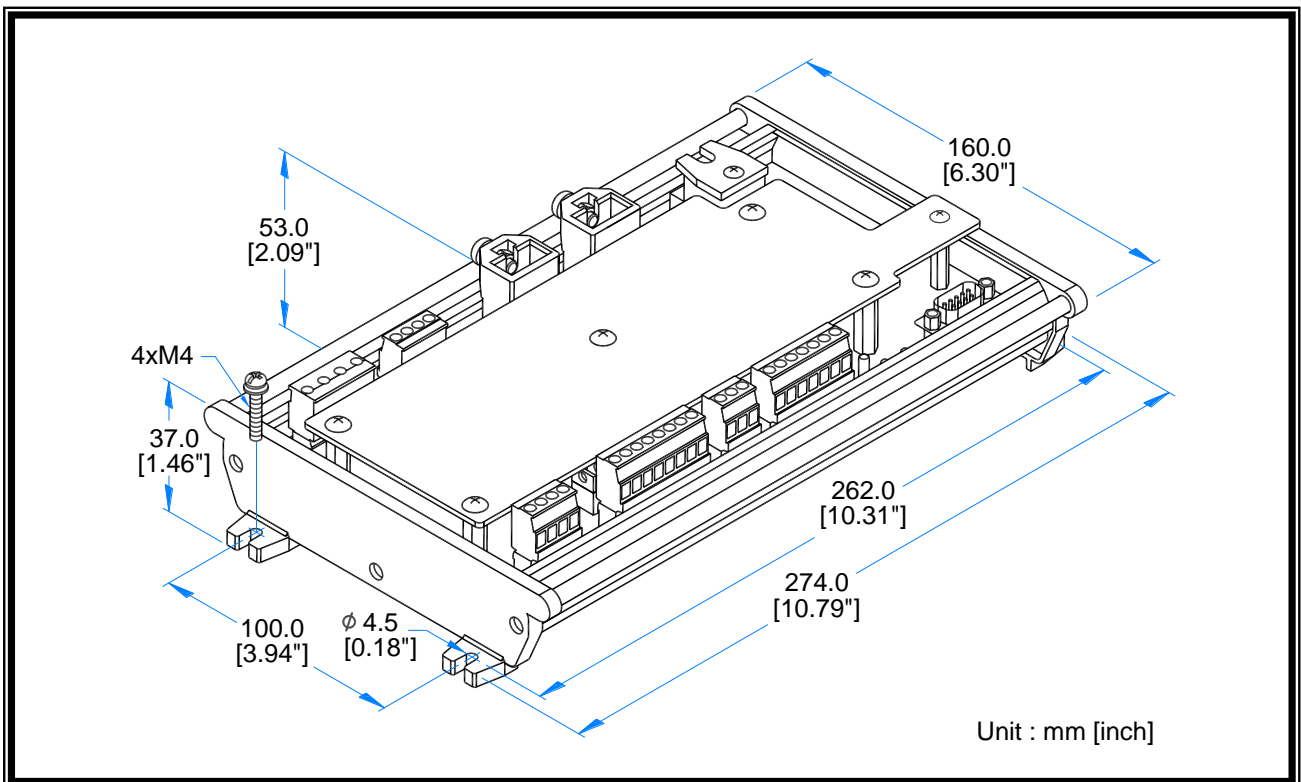



### 3.1.3 Wiring Installation Precautions (Figure 5)

The GC4K-E controller has cable fixing bars on both sides. When installation of wiring is completed all wiring connected to the controller should be securely fixed to these bars to reduce the possibility of bad connections caused by vibration.

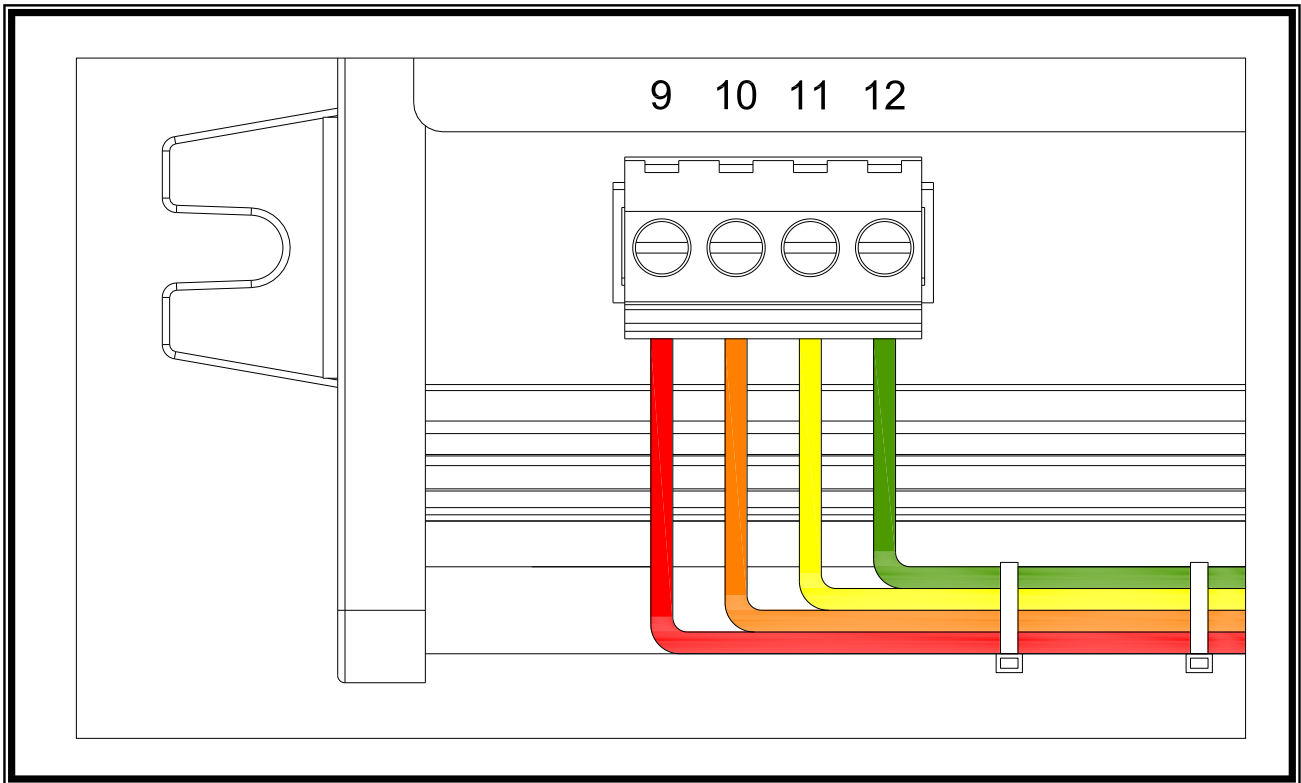

### 3.2 Controller Connections With Display Unit (Figure 6)

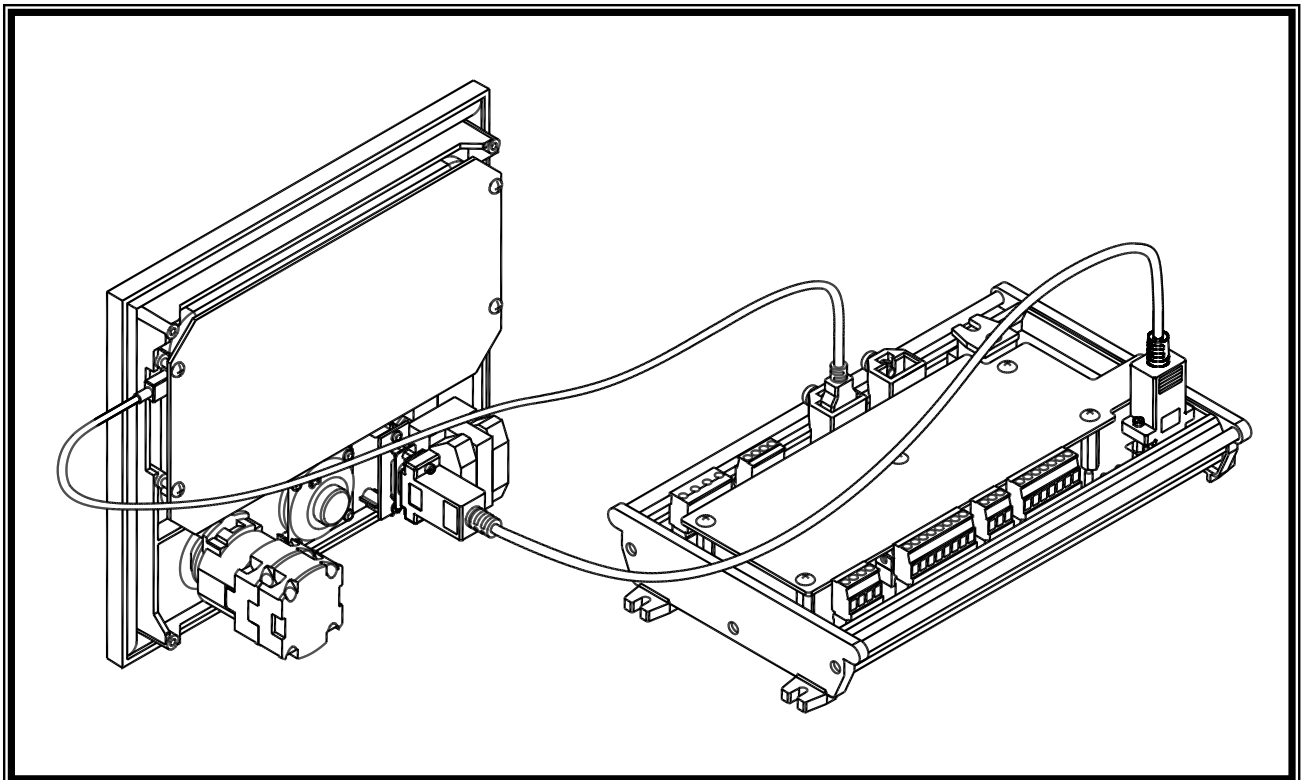

### 3.2.1 USB Connector Attachment Instructions (Figure 7)

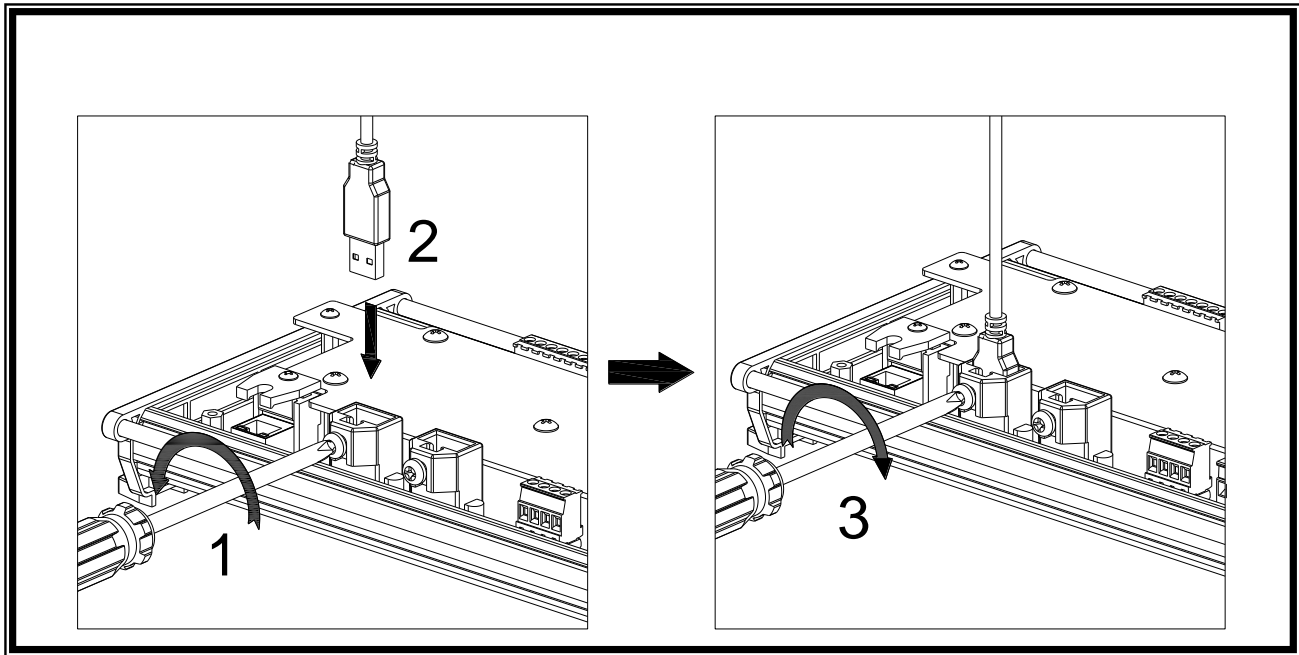

### 3.2.2 RJ45 Connector Attachment Instructions (Figure 8)

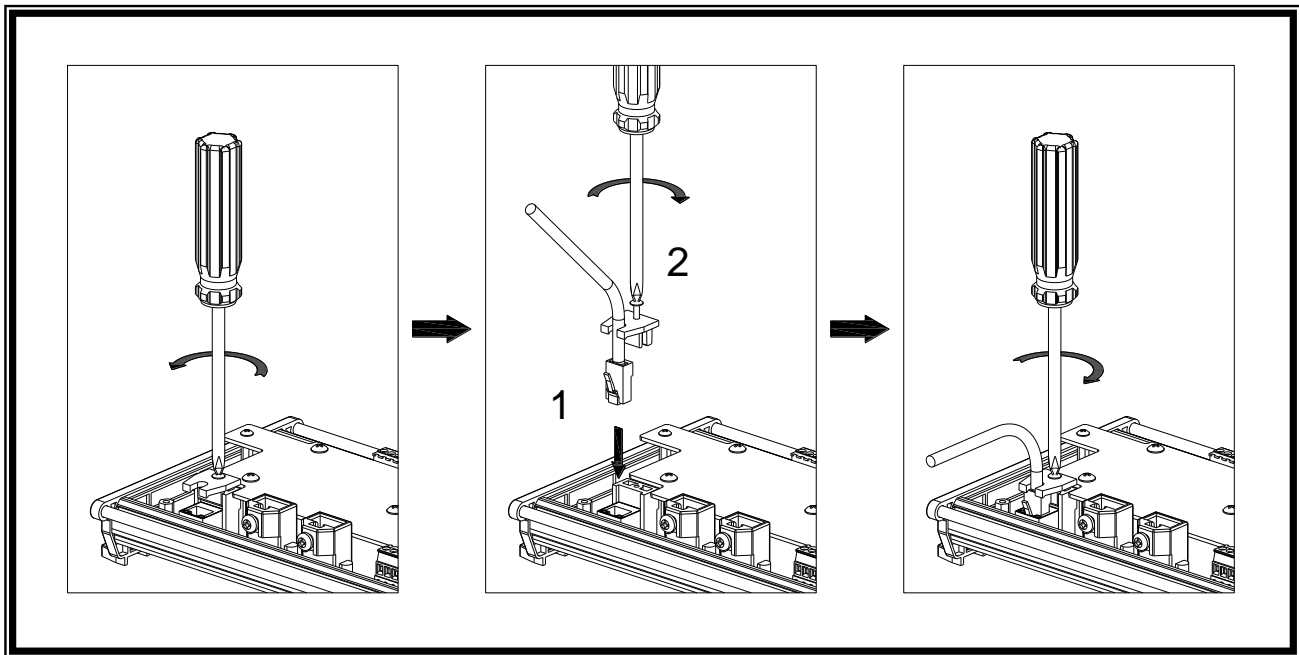

**⚠ CAUTION**

1. If the USB or RJ45 connectors are not attached correctly it could lead to loosening of connections from vibration after extended operation of the genset.
2. A loose USB connection between the GC4K-E controller and the GC4K-D07 display panel could lead to the unit not functioning properly.
3. When RJ45 is used a loose connection could lead to loss of remote monitoring and control functions through Ethernet.

### 3.3 Generator Connections With GC4K-E Controller

**⚠ WARNING**

Connections should be made in the order listed below :

1. Complete all wiring connections except battery power.
2. Confirm that all wiring is correct.
3. Place Mode Selector to OFF.
4. Connect to Battery Power.

#### 3.3.1 GC4K-E Connection Terminal Numbers and Locations Drawing (Figure 9)

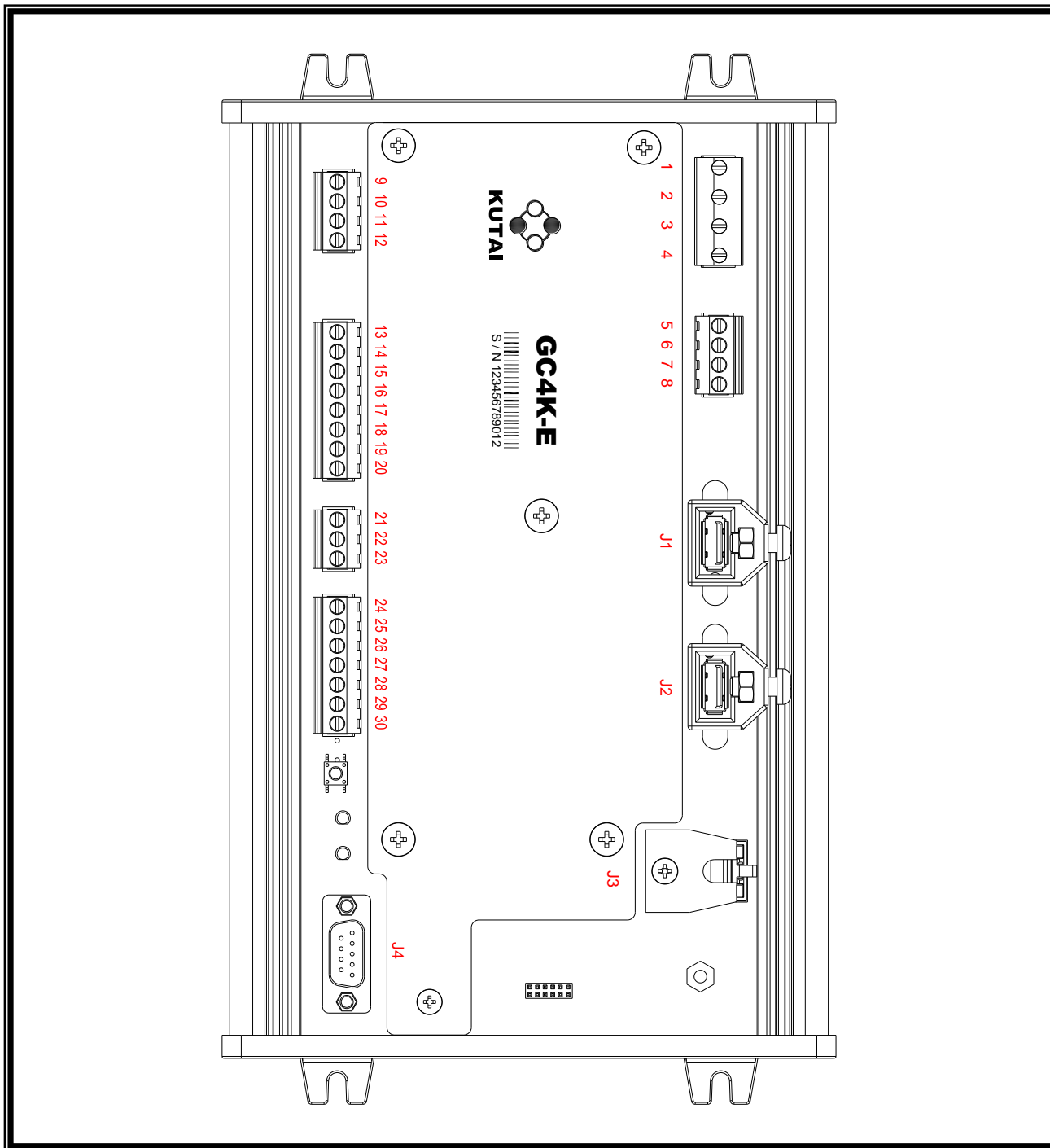

### 3.3.2 GC4K-E Connection Terminals, Communication Ports, and Connectors

PIN No.	Connection	Recommended wire size	Description
1	AC Power Input (V1)	AWG 18	Connect to AC power source L1 phase
2	AC Power Input (V2)	AWG 18	Connect to AC power source L2 phase
3	AC Power Input (V3)	AWG 18	Connect to AC power source L3 phase
4	AC Power Input (N)	AWG 18	Connect to AC power source N phase
5	Battery Power Input ( B+ )	AWG 12	Connect to positive (+) terminal on battery
6	NC		No connection
7	Battery Power Input (B-)	AWG 12	Connect to negative (-) terminal on battery
8	Battery Power Input (B-)	AWG 12	Connect to chassis grounding (-)
9	CT secondary common input	AWG 13	Generator current transformer common connection and CT earth connection
10	CT secondary input (L1)	AWG 13	Generator L1 current transformer connection
11	CT secondary input (L2)	AWG 13	Generator L2 current transformer connection
12	CT secondary input (L3)	AWG 13	Generator L3 current transformer connection
13	Start Signal output	AWG 13	Connect to Starter Auxiliary Contactor (maximum output 10 Amps)
14	Fault Alarm Signal output	AWG 18	Connect to Fault Alarm Indicator LED (maximum output 2.5 Amp)
15	Accessory ON / control panel illumination output	AWG 18	Connect to terminal using Accessory ON output (maximum output 2.5 Amp)
16	Engine Idle Control Output	AWG 18	Connect to engine idle controller (maximum output 2.5 Amp)
17	Engine Stop Signal Output	AWG 13	Connect to engine stop auxiliary contactor (maximum output 10 Amp)
18	User-defined Output-B	AWG 18	Connect to any device for fault alarm indication or protection action (maximum output 2.5 Amp)
19	User-defined Output-A	AWG 18	Connect to any device for protection action or block heater relay (maximum output 2.5 Amp)
20	Preheat Signal Output	AWG 18	Connect to engine glow plug auxiliary relay (maximum output 2.5 Amp)
21	CAN-HI input	AWG 20	Connect to ECU CAN-HI
22	CAN-LO input	AWG 20	Connect to ECU CAN-LO
23	Shield terminal	AWG 20	Connect to an isolated ground
24	User-defined input common	AWG 18	Connect to User-defined input common
25	D+ terminal output	AWG 18	Connect to charge alternator D+ terminal
26	Fuel Level Sensor Input	AWG 18	Connect to fuel level sensor
27	User-defined Input-A	AWG 18	Input must be a "dry" contact type
28	User-defined Input-B	AWG 18	Input must be a "dry" contact type
29	Remote Start Signal Input	AWG 18	Connect to start signal from Automatic Transfer Switch or to a remote start switch



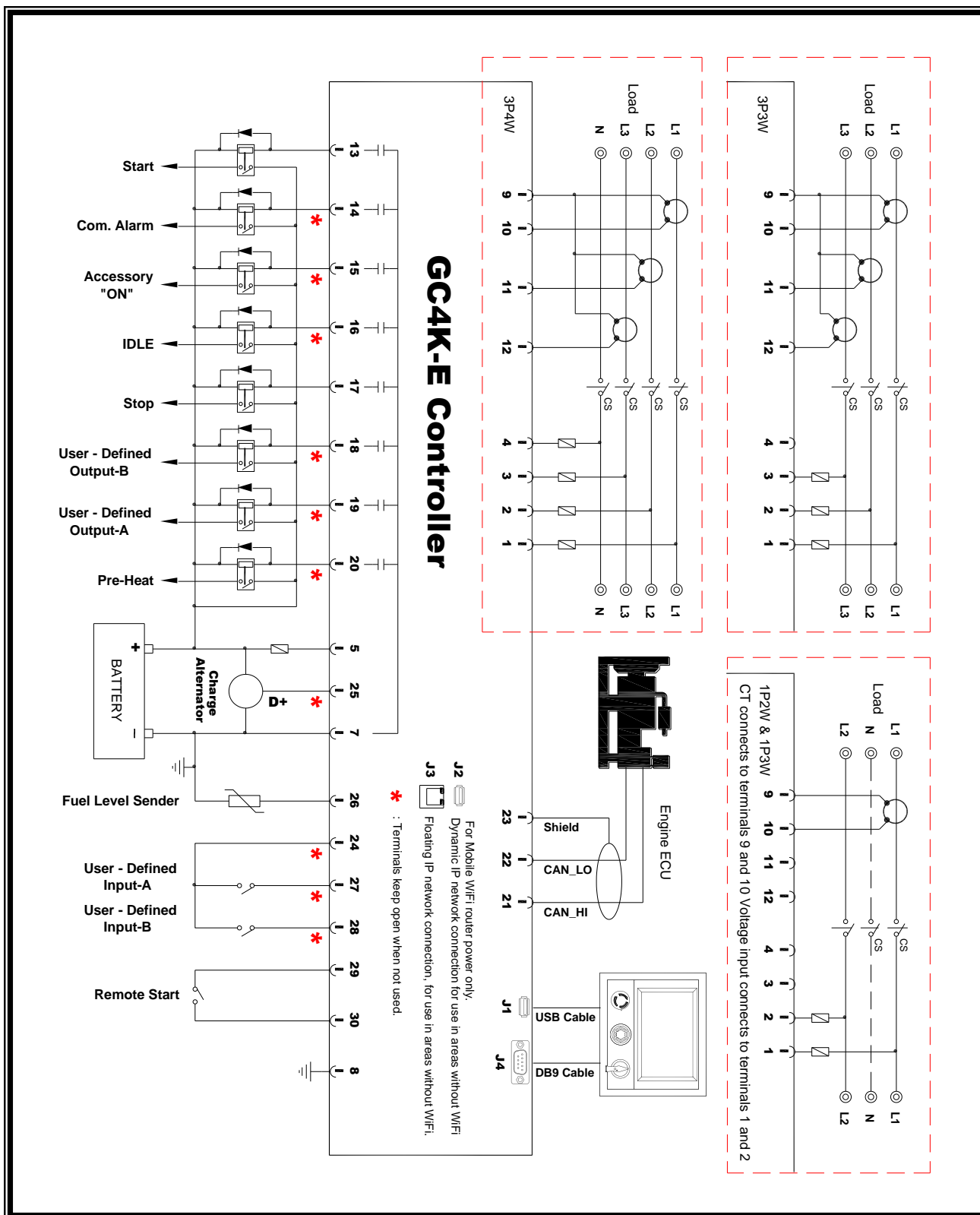

<b>PIN No.</b>	<b>Connection</b>	<b>Recommended Wire Size</b>	<b>Description</b>
<b>30</b>	Remote Start Signal Input	AWG 18	Connect to start signal from Automatic Transfer Switch or to a remote start switch
<b>J1</b>	Display screen USB port		Connect to GC4K-D07 USB port
<b>J2</b>	WiFi router power output		Connect to WiFi router power input (USB cable)
<b>J3</b>	Ethernet jack		Connect to Ethernet cable (RJ45)
<b>J4</b>	Connector for control signals		Connect to GC4K-D07 (DB9)

### 3.3.3 Recommended Wiring Diagram



## SECTION 4 : SYSTEM PARAMETERS SETTINGS

### 4.1 Explanation of Terms and Icons Used With GC4K-E

Special Term	Explanation
Owner	This is the highest authority. The owner of the unit and has the following authorities : 1. Can monitor all parameters of the unit. 2. Can delete the event log or reset running hours. 3. Can edit operator and viewer status and assign a generator name. 4. Has the original operator authority with ability to change parameter settings. If the owner assigns operator authority to another account then this authority will automatically be removed, however the owner account will still possess viewer monitoring rights and the authority to take back or reassign operator authority to another account.
Operator	Remote operator authority with ability to change system settings, as well as view all operating parameters. A controller will allow only one operator connection.
Viewer	Authority to monitor all parameters and operating status. The controller allows up to seven Viewer connections at one time.
Device Binded	All controllers to be remotely monitored must first be bound to an owner by executing the binding procedure, if this binding process is not completed then the Kutai remote server will not allow connection to the controller. (See Section 6.3.3)
Owner Switch	Whoever presses the “owner switch” will have owner authority for the unit. (See Figure 2)
Replicate Settings	When it is necessary to set system parameters for a group of controllers, one controller can be chosen as the Master. The replicate settings will dump the settings of the “Master controller” to any controllers connected on the same WiFi domain. (Refer to 4.9)
Onsite	Refers to equipment installed on the genset, that is GC4K + GC4K-D07
Remote	Refers to an operator or viewer using a mobile device with GenOnCall® Remote APP
	This symbol at the beginning of a section indicates an onsite operation
	This symbol at the beginning of a section indicates a remote device operation
	This symbol at the beginning of a section indicates an owner operation
	This symbol indicates the “owner” of a controller (See above)
<i>Setting Permission</i>	Italic font indicates text displayed on the screen

### 4.2 Precautions

**⚠ CAUTION**

All settings highlighted in **yellow** must be confirmed before the genset is started for the first time. Any improper settings could lead to permanent damage to the unit.



### 4.3 Open Owner Functions Screen

With Mode selector in OFF position pressing the Owner Switch on the controller will display the following options.

- Unbind current Owner from the controller (Refer to Section 6.3.5)
- Enable Onsite Setting of parameters (Refer to Section 4.3.1)
- Enable Remote Setting of parameters (Refer to Section 4.3.1)
- Carry out replicate settings (Refer to Section 4.9)



**Enable Onsite Setting Permission**

#### 4.3.1 Onsite and Remote Parameters Setting

Whether settings are made Onsite or by the Remote APP, the Owner SW must be pressed for 2 seconds each time to open the Owner Functions screen. The controller will open a 2-hour period for the user to make changes to settings.

Turn the Mode Selector to OFF ► Press the Owner SW on the controller ► Click on *Enable Onsite Setting Permission* or *Enable Remote Setting Permission* ► Press **ENTER** to enable Setting Parameters.

### 4.4 Language Setting

Press  ► press *Language / Idioma / 語言* ► click on English, Spanish, or Traditional Chinese.

### 4.5 System Settings



System settings can only be made with the controller in the OFF mode and the setting permission opened otherwise setting selection options will turn the color grey to notify the user that system settings cannot be changed. However, the user can still enter the settings screen to view all settings.

## 4.5.1 Voltage Parameters Settings

### 4.5.1.1 Phase

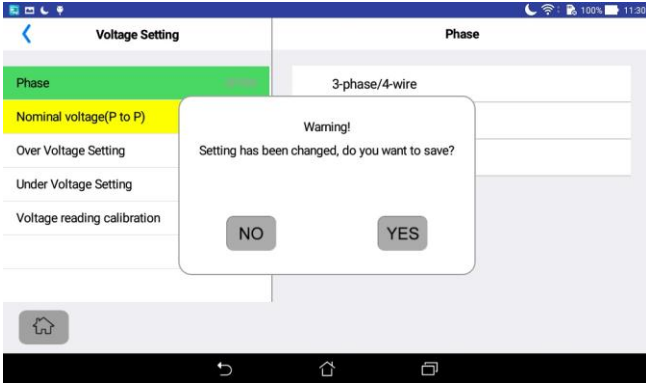
Press  ► Press *System Setting* ► Press *Voltage Setting* ► Press *Phase* ► Press correct option.



After setting is complete, pressing “<” to return the previous page or pressing  to return to the Home Page, or choosing any another Setting option, a window will pop up on the screen asking if you want to save the setting. Press  to Save.





#### Save change to settings has failed

Press  to execute save setting again.

Press  to abandon new setting value. Original setting will not be changed.

### 4.5.1.2 Nominal Voltage Setting

Press  ► Press *System Setting* ► Press *Voltage Setting* ► Press *Nominal Voltage (P to P)*

1. If no instrument transformer is used Press the setting box ► Use the keypad to input the voltage ► Press  to enter.
2. If voltage is > 500 Vac it will be necessary to use an instrument transformer. Turn ON *Use Instrument Transformer*  ► Use the keypad to input the transformer primary and secondary voltages.

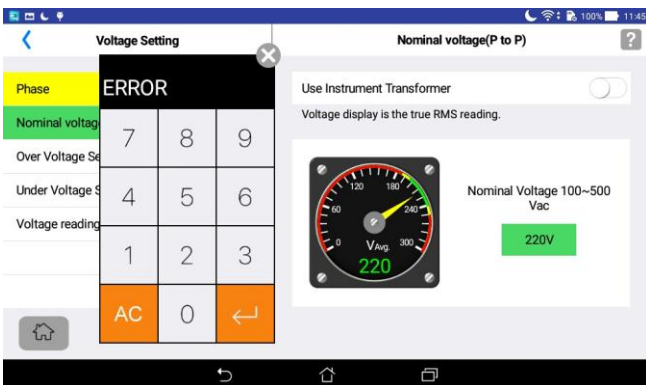



#### ERROR Warning

For all settings, if an entered value exceeds that allowed range then an “ERROR” warning will appear on the screen. Press  to clear.

### 4.5.1.3 Over Voltage Protection Setting

Press  ► Press *System Setting* ► Press *Voltage Setting* ► Press *Over Voltage Setting* ► Turn ON *Over Voltage Warning* and *Over Voltage Shutdown*  ► Click on setting boxes ► Use the keypad to input the Over Voltage Protection values and Permitted Delay time ► Press  to enter.

### 4.5.1.4 Under Voltage Protection Settings

Press  ► Press *System Setting* ► Press *Voltage Setting* ► Press *Under Voltage Setting* ► Turn ON *Under Voltage Warning* and *Under Voltage Shutdown*  ► Click on setting boxes ► Use the keypad to input the Under Voltage Protection values and Permitted Delay time ► Press  to enter.



### 4.5.1.5 Voltage Readings Calibration

Displayed voltages are true RMS values. If an averaging voltmeter is used to carry out calibration it could possibly cause displayed values to be inaccurate, causing Over Voltage and Under Voltage protections to malfunction or become ineffective.

Press  ► Press *System Setting* ► Press *Voltage Setting* ► Press *Voltage Reading Calibration* ► Scroll to the desired value in the setting box.

## 4.5.2 Current Parameters Settings

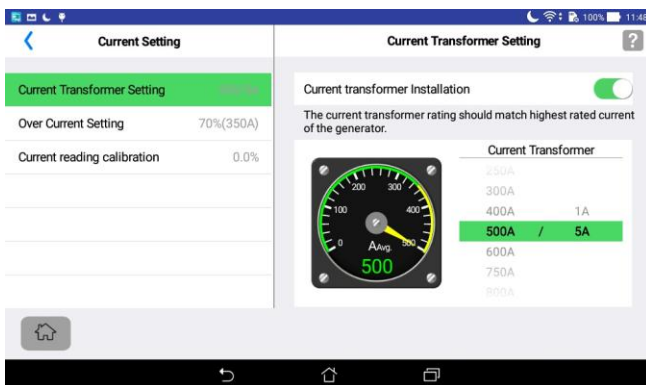

### 4.5.2.1 Current Transformer (CT) Setting

Press  ► Press *System Setting* ► Press *Current Setting* ► Press *Current Transformer Setting* ► Turn ON *Use Current Transformer*  ► Press the setting boxes ► Scroll to the primary and secondary current values for the current transformer used.



Current Transformer Setting screen

### 4.5.2.2 Over Current Protection Settings

Press  ► Press *System Setting* ► Press *Current Setting* ► Press *Over Current Setting* ► Turn ON *Over Current Warning* and *Over Current Shutdown*  ► Press the setting boxes ► Use the keypad to input the Over Current Protection values and Permitted Delay time ► Press  to enter.

---

### 4.5.2.3 Current Readings Calibration

Displayed currents are true RMS values. If an averaging ammeter is used to carry out calibration it could possibly cause displayed values to be inaccurate, causing over current protection to malfunction or become ineffective.



Press  ► Press *System Setting* ► Press *Current Setting* ► Press *Current Reading Calibration* ► Scroll to the desired value in the setting box.

### 4.5.3 Frequency Parameters Settings

#### 4.5.3.1 Nominal Frequency Setting

Press  ► Press *System Setting* ► Press *Frequency Setting* ► Press *Nominal Frequency* ► Select 50 Hz or 60 Hz.

#### 4.5.3.2 Over Speed Protection Settings

Press  ► Press *System Setting* ► Press *Frequency Setting* ► Press *Over Speed Setting* ► Turn ON *Over Speed Warning* and *Over Speed Shutdown*  ► Press the setting box ► Use the keypad to input the Over Speed Protection and Permitted Delay time values ► Press  to enter.

**⚠ CAUTION**

**For safety purposes the Over Speed Warning and Over Speed Shutdown cannot both be turned OFF at the same time. If an attempt to turn OFF both at the same time a warning will appear on the controller screen.**

#### 4.5.3.3 Under Speed Protection Settings

Press  ► Press *System Setting* ► Press *Frequency Setting* ► Press *Under Speed Setting* ► Turn ON *Under Speed Warning* and *Under Speed Shutdown*  ► Press setting boxes ► Use the keypad to input the Under Speed Protection values and Permitted Delay time ► Press  to enter the values.

### 4.5.4 Fuel Level Parameter Setting



#### 4.5.4.1 Fuel Level Sender Settings

Press  ► Press *System Setting* ► Press *Fuel Level Setting* ► Press *Fuel Level Sender* ► Select one of the following.

1. None.
2. **Fuel Level Sender** ► Press setting box ► Use the keypad to input the *Full position* and *Empty position* resistance values ► Press  to enter.
3. **Fuel Level Switch** ► Press *Low Fuel Level to Open* or *Low Fuel Level to Close*.



#### 4.5.4.2 Low Fuel Level Response Settings

Press  ► Press *System Setting* ► Press *Fuel Level Setting* ► Press *Low Fuel Level Response*.

1. Using a Fuel Level Sender turn ON *Low Fuel Level Warning* or *Low Fuel Level Shutdown*  ► Press setting boxes ► Use the keypad to input the Low Fuel Level Response activation values and Permitted Delay time ► Press  to enter.
2. Using a Fuel Level Switch Press *Low Fuel Level Response : Warning* or *Shutdown* ► Press setting boxes ► Use the keypad to input the Low Fuel Level Response Permitted Delay time ► Press  to enter.

## 4.5.5 User Defined Input and Output Settings

### 4.5.5.1 User Defined Input-A and User Defined Input-B Settings

Press  ► Press *System Setting* ► Press *User Defined I/O Setting* ► Press *User Defined Input-A* ► Turn ON *Input-A*  ► Press *Alarm Title Box* ► Use the keyboard to type in the name of the alarm and fill out all of the setting items ► Press  to enter.

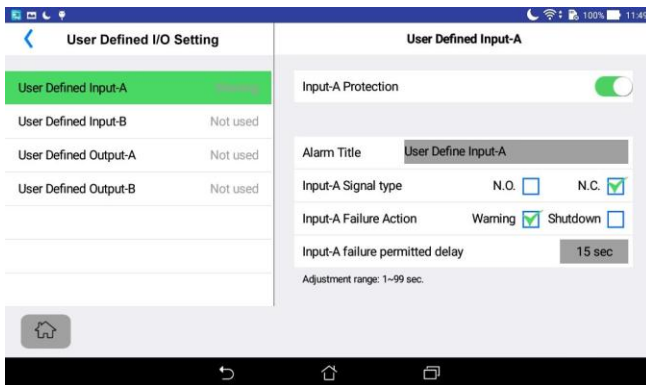



User Defined Input-A setting

#### NOTICE



When a water level switch or other protection device is used, either User Defined Input -A or -B can be used for the function.

### 4.5.5.2 User Defined Output-A and User Defined Output-B Settings

Press  ► Press *System Setting* ► Press *User Defined I/O Setting* ► Press *User Defined Output-A* ► Turn ON *Output-A Function*  ► Click the check box for Output fault type and protection action 

## 4.5.6 Engine Start / Stop Setting



### 4.5.6.1 Engine Start Settings

Press  ► Press *System Setting* ► Press *Engine Start / Stop Setting* ► Press *Engine Start Settings* ► Press setting boxes ► Use the keypad to input values for *Start Attempts*, *Cranking Timer*, *Interval Between Crankings* and *Genset Running Reminder* ► Press  to enter the value ► Press *Genset Running Reminder* ► Press settings boxes ► Use the keypad to input Genset Running Reminder time ► Press  to enter the value.

### 4.5.6.2 Engine Idle Timer



Press  ► Press *System Setting* ► Press *Engine Start / Stop Setting* ► Press *Idle Timer* ► Press setting box ► Use the keypad to input value for Idle Timer ► Press  to enter.

### 4.5.6.3 Engine Cool Down Timer

Press  ► Press *System Setting* ► Press *Engine Start / Stop Setting* ► Press *Engine Cool Down Timer* ► Press setting box ► Use the keypad to input value for Engine Cool Down Timer ► Press  to enter.

## 4.5.7 Battery and Charge Alternator Settings

### 4.5.7.1 Battery Voltage Warning Setting

Press  ► Press *System Setting* ► Press *Battery & Charge Alternator Setting* ► Press *Battery Voltage Warning Setting* ► Turn ON *Battery Over Voltage Warning* and *Battery Under Voltage Warning*  ► Press settings boxes ► Use the keypad to input values for *Battery Under Voltage* and *Over Voltage Warning* ► Press  to enter 【*Battery Voltage Warnings are disabled during engine cranking.*】

### 4.5.7.2 Charge Alternator Protection Settings

Press  ► Press *System Setting* ► Press *Battery & Charge Alternator Setting* ► Press *Charge Alternator Setting* ► Turn ON *Warning* and *Shutdown*  ► Press setting box ► Use the keypad to input minimum *Charge Alternator output voltage* and *permitted delay time* ► Press  to enter.



## 4.5.8 Location Service

The location service function is always operating and can obtain any GPS, WiFi or 3G / 4G base station positioning information. The control unit can provide current generator location to the Operator and any remote Viewers.

### NOTICE

1. Location information obtained from mobile devices relies on the different methods of GPS, WIFI, or 3G/4G mobile data networks, so there will be deviations from actual location of several meters to several hundred meters.
2. Android smart mobile devices in mainland China must download the Baidu map app and can only use GPS to provide location function. Neither WiFi or 3G / 4G base station positioning method can be used
3. This location function provides users with only an approximate generator location. Customers cannot require the manufacturer provide additional services beyond these provided or accept any legal obligation to provide such services.

## 4.5.9 Service Maintenance Reminder

Press  ► Press *System Setting* ► Press *Service Maintenance Setting* ► Turn ON *Service Maintenance Reminder*  ► Press setting box ► Use the keypad to input a value for *Service Maintenance Remind Hour* ► Press  to enter the value.

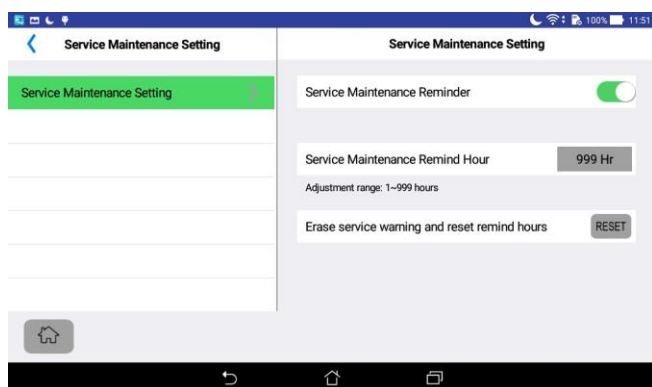



### Service Maintenance setting screen



Clicking the “RESET” button will clear Service Maintenance Reminder and restart the Service Maintenance Reminder countdown timer.

## 4.5.10 Voice and Audio Alarm Settings

### 4.5.10.1 Audio Alarm Setting

Press  ► Press *System Setting* ► Press *Voice and Audio Alarm Settings* ► Press *Audio Alarm Setting* ► Turn ON *Genset Shutdown Failure Audio Alarm*  ► Adjust alarm volume.

### 4.5.10.2 Voice Warning Setting

Press  ► Press *System Setting* ► Press *Voice and Audio Alarm Settings* ► Press *Voice Warning Setting* ► Click on *Voice Warning Language-1* and *Voice Warning Language-2*  ► Select Language ► Adjust alarm volume.

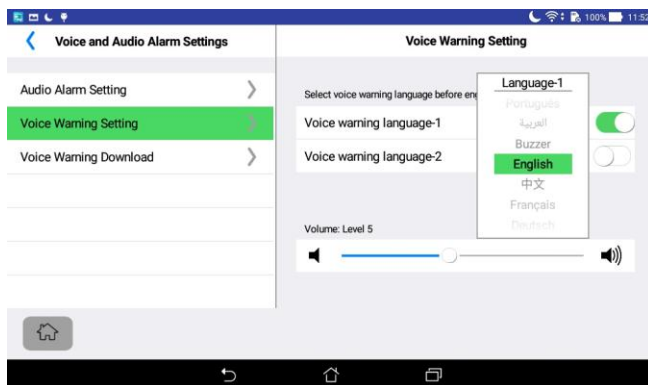





Voice Warning Setting screen

### 4.5.10.3 User Recorded Engine Start Voice Warning

In addition to built-in engine prestart voice warnings in Chinese, English, Japanese, Hindi, Spanish, French, Arabic, Russian, Portuguese and German, the GCU-4K-E can also record personal voice warnings.

#### 4.5.10.3.1 Record Engine Start Voice Warning

Press  ► Press *System Setting* ► Press *Voice and Audio Alarm Settings* ► Press *User Recorded Voice Warning* ► Press  to start recording the engine start voice warning ► When recording is completed press  to end voice recording ► Click on  to listen to the recording just made.

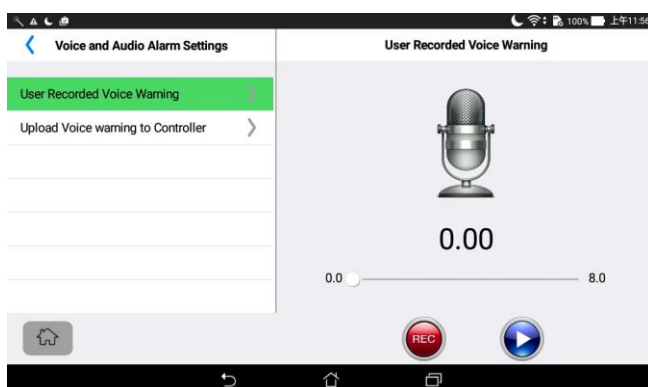



Record Engine Start Voice Warning screen



### 4.5.10.3.2 Engine Start Voice Warning Download Procedure

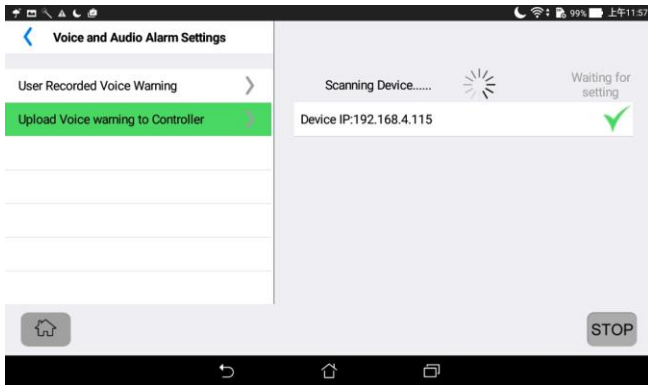

#### Operation on Mobile Device

Connect the mobile device used to record the Engine Start Voice Warning to the same Wi-Fi domain as the GC4K-E control unit ▶ Press  ▶ Press *System Setting* ▶ Press *Voice and Audio Alarm Settings* ▶ Select *Voice Warning Upload* ▶ Press  to execute voice warning file transfer ▶ Press  to leave this operation.



Screen when mobile device has completed voice warning file transfer

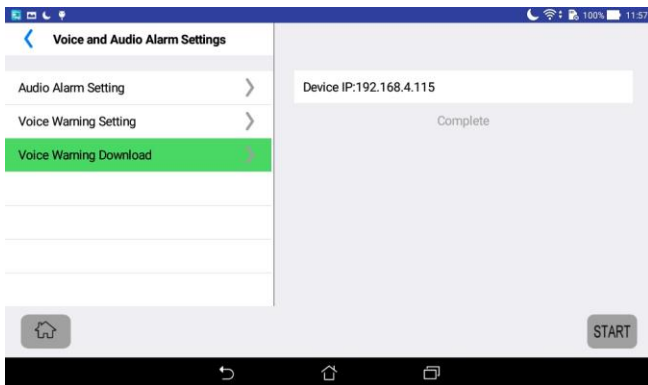

#### Operation on GCU-4K Display Unit Screen

Press  ▶ Press *System Setting* ▶ Press *Voice and Audio Alarm Settings* ▶ Select *Voice Warning Download* ▶ Press  to execute voice warning file transfer ▶ Press  to leave this operation.





Screen when control unit has completed voice warning file download

### 4.5.11 Communication Module Settings



Press  ▶ Press *System Setting* ▶ Press *Communication Module* ▶ Press *Modbus KCU-05* ▶ Turn ON *Modbus application*  ▶ Click on the *Baud Rate* and *Parity Bit* and scroll to find the correct settings ▶ Press the *Slave Address* Setting box ▶ Use the keypad to input the module address ▶ Press  to enter.

### 4.5.12 Factory Setting Recovery

Press  ▶ Press *System Setting* ▶ Press *Factory Setting Recovery* ▶ Pressing  to restore all factory settings except for voltage and current calibration settings.

---

### 4.5.13 Security Alert settings



Press  ► Press *System Setting* ► Press *Security Alert* ► Turn ON *Genset Position Shifted* and *Battery Power Removed Notice*  ► Adjust the Motion Sensitivity setting up or down

#### NOTICE

If Motion Sensitivity setting is too high the control unit may generate a Push Notification due to slight vibrations. In this case the value of the setting should be adjusted downward, which could potentially cause the genset position shifted Push Notification to become ineffective if set too low.

### 4.5.14 Erase Event Log, Reset Running Hours or KWH meter to zero

Only the Owner will display the option for Erase Event log, Reset Running Hours and KWH meter to zero

Press  ► Press *System Setting* ► Press *Event Log, Running Hours & KWH Meter* ► Press *Erase Event Log, Reset Running Hours Timer* or *Reset KWH Meter* ► Press  can reset Running Hours and KWH meter or permanently erase the Event Log.



### 4.6 About This Unit

The program version numbers and product serial numbers of the GCU-4K control unit and the display unit are provided for reference by the user.

### 4.7 WIFI Settings

Refer to Section 6.2.1 in the User Manual

### 4.8 Time and Date Settings





Press  ► Press *Time and Date Settings* ► Select *Select Time Zone* ► Select the Time Zone of the unit ► *Automatically Calibrate time* 

### 4.9 Replicate Settings





Master GC4K-E device : This unit supplies all settings to be copied.

Receiving devices (GC4K-E) : The number of receiving devices can be up to 255 units. All parameter settings will be copied from the Master device.

#### 4.9.1 Settings Transfer Procedure on Master GC4K-E Device

Connect the Master GC4K-E to the same WiFi domain as the receiving devices ► Turn the Mode Selector to OFF ► Press and hold Owner SW for two seconds ► Select *Replicate settings* ► Press  to open Settings Transfer function ► Press *Dump Setting to Other Controller* ► Press  to execute Settings Transfer ► After settings have been copied to all receiving devices ► Pressing  will abandon Settings Transfer ► If settings have been transferred successfully to all control units press  to end Settings Transfer.

#### 4.9.2 Operations on Receiving Devices

Connect devices to the same WiFi domain as Master GC4K-E device ► Turn Mode Selector to OFF ► Press and hold Owner SW for two seconds ► Press *System Settings Transfer* ► Press  to open Settings Transfer function ► Press *Request Settings Dump from Master device* ► Press  to execute Settings Transfer ► Pressing  at any time to abandon transfer procedure ► Each receiving device will indicate  when transfer completed ► press  to end Settings Transfer.

## SECTION 5 : UNIT OPERATING TESTS

### 5.1 Mode Selector

In AUTO mode engine Run or Stop status is determined by Remote Start terminals 29 & 30. A voice warning will broadcast before engine start. A cool down period will occur before engine shuts down unless the Remote Start signal is closed again.

AUTO is displayed in the lower left hand corner of the screen 

1. AUTO flashing : Standby mode
2. AUTO steady : Running mode

1. Engine shuts down directly with no delay for cool down.
2. Clears current failure messages.

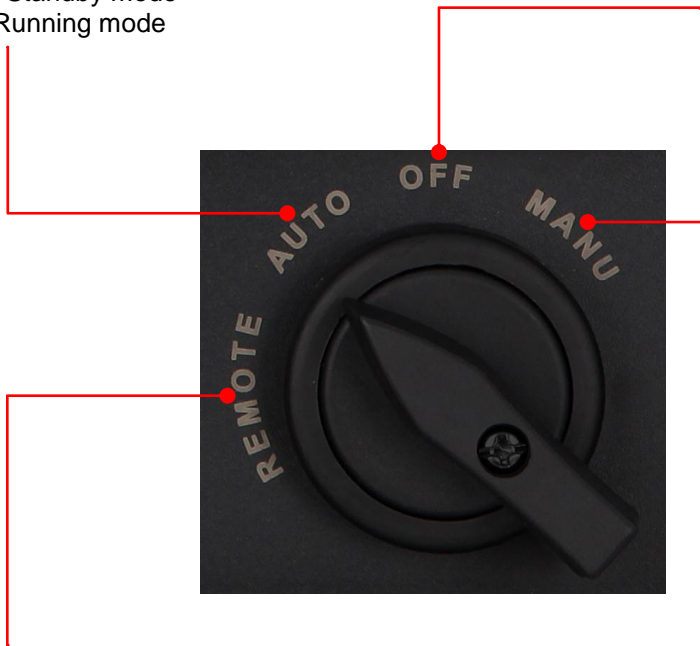

Direct start - no voice warning

1. Remote mode is only effective when the controller is connected to a network (See 6.1.1)
2. The Owner can assign one Operator authority to operate the unit and change settings. Once this authority has been assigned to another account the Owner's operating authority will automatically disappear but will still retain Viewer authority (See 6.3.3).
3. Only in Remote mode can the Operator Start / Stop the genset and change settings.

#### **⚠ WARNING**

The GCU-4K controller can execute Remote Start at any time in REMOTE or AUTO mode. The directives below must be followed otherwise personal injury or death could result :

1. The generator should be surrounded by a protective fence.
2. A permanent warning sign must be posted clearly to alert personnel. The warning sign should convey that "Generator could start at any time".
3. The Engine Start Voice Warning should be enabled and its operation should be confirmed (See 4.5.10.2)
4. To ensure the safety of personnel the Mode Selector should be in OFF mode or the battery disconnected when maintaining or working around the genset.

## 5.2 Display Pages

The unit has five different display pages, which can be scrolled left and right to change.



Location map

Voltage/Current Recorder

Event Log

Home Page

Electrical Power Readings

J1939 Data Page

### 5.2.1 Home Page

The Home page contains all major engine and alternator parameters. Press  to return to the Home Page from other pages.











#### Analog Gauge Meters

Press and hold any gauge display on Home Page or Electrical Power Readings page to enable choice of display: Voltage, Current, Frequency, KVA, KW, KWH, KVAR or PF

#### Unit Name (Identifier)

Genset unit name (identifier) Can be edited by Owner. (See 6.3.3)

#### Status Icons

-  : Connected to remote server
-  : Unit Location established
-  : Remote Operator connected
-  : Remote Viewer connected
-  : Controller settings enabled
-  : Block Heater ON
-  : Close Remote APP
-  : Close current page
-  : HELP function
-  : Download software updates (WIFI connection only)
-  : Previous page



#### Oil Pressure Gauge



Press and hold on meter to switch between Psi and Bar

#### Fuel Level Gauge

Press and hold on meter to switch between °C and °F

#### Message Area



Operating status and Messages

-  : Steady = Stopped
-  : Rotating= Running
-  : Countdown timers
-  : Warning message
-  : Shutdown message

**Operating Mode**  
AUTO/OFF/MANU

**Electrical Power Readings**

#### Function Selection

-  : Function Selection and System Parameter Settings
-  : Home Page
-  : Mute

**Running Hours**

**Maintenance Reminder**  
Countdown timer

**Battery Voltage**

## 5.2.2 Electrical Power Readings

The Electrical Power Readings includes real time display of all phase Voltage and Current, Frequency, KVA, KW, KVAR, and Power Factor (PF).



## 5.2.3 SAE J1939 Data Page

GC4K-E controller can display up to 53 items of engine data from ECU (J1939)

Parameter Value

J1939 SPN code

Parameter name

Item	SPN	Description	Value
01	573	Transmission Torque Converter Lockup Engaged	--
02	92	Engine Percent Load At Current Speed	--
03	512	Driver's Demand Engine - Percent Torque	--
04	513	Actual Engine - Percent Torque	--
05	441	Auxiliary Temperature 1	--
06	1387	Auxiliary Pressure #1	--
07	1239	Engine Fuel Leakage 1	--
08	1240	Engine Fuel Leakage 2	--

### NOTICE

GC4K-E control module provides at most 53 Electronic Engine Control data parameters for display, however, the actual number of items that can be displayed will vary slightly because of different brands of engine computer (ECU). There must be open access to the data according to the EEC installed.

## 5.2.4 Event Log Page

The control module can record the most recent 250 events. Each event record includes Event Type, Time of Occurrence, and an Event Description.

**Event type :**  
Event type include fault **Warning**, **Shutdown**, Engine Start, Change of settings, and other events.

**Time of Occurrence**

**Event Description**

Item	mm/dd/yy	Time	Event	Details
0001	05/24/17	13:17	Warning	User Define Input-A
0002	05/24/17	13:17	Warning	Oil pressure Sensor Failure
0003	05/24/17	13:17	Warning	Temperature Sensor Failure
0004	05/24/17	13:17	MANU	Engine Stop
0005	05/24/17	13:17	Shutdown	Emergency Stop Shutdown
0006	05/24/17	13:17	MANU	Engine Cranking
0007	05/24/17	13:14	OFF	Engine Stop
0008	05/24/17	13:14	MANU	Engine Cranking

## 5.2.5 Voltage Level / Current Level Recorder Screen

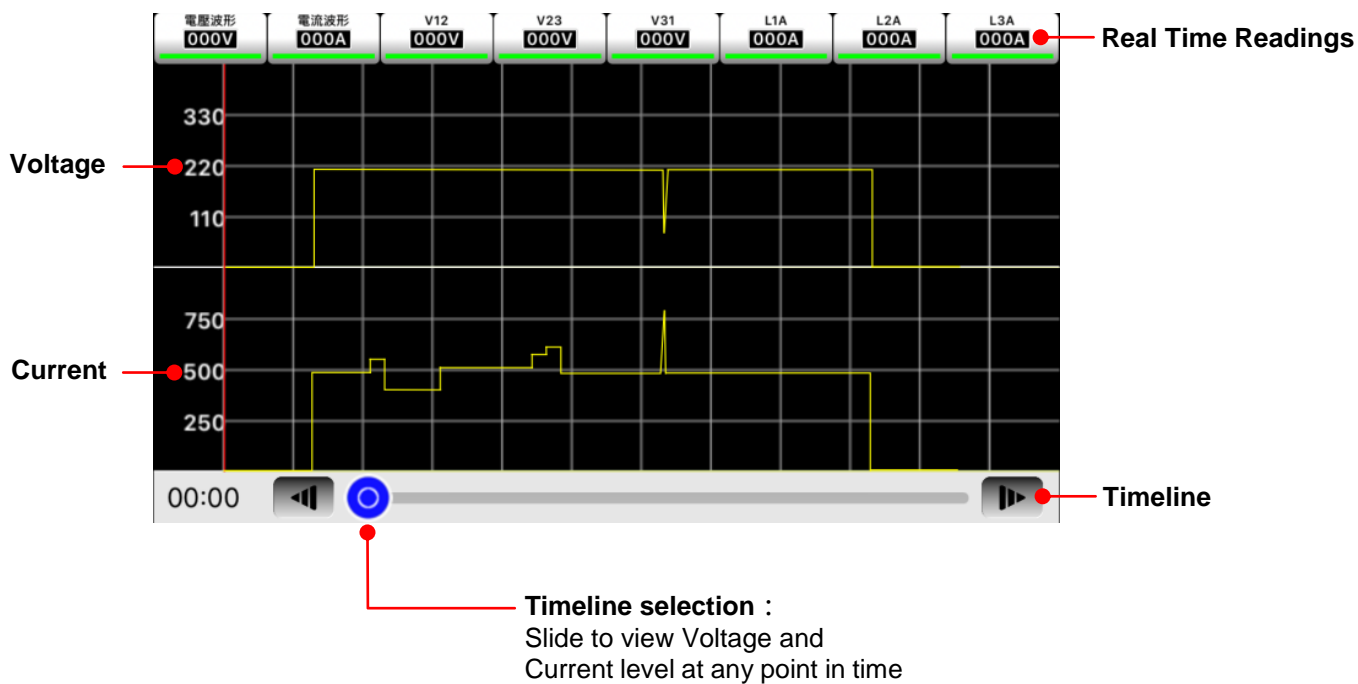







## 5.2.6 Location Map Page

The Location Map Page is only displayed on the Remote mobile device screen.

### Unit Position Symbol

-  : Currently connected unit
-  : Unit running
-  : Unit is shutdown
-  : A fault has occurred in the unit

### Connection button

Clicking on any Unit Position Symbol will open a connection window. Click the connection button in the window to connect with the unit directly.



## 5.3 Initial Operation (MANU and AUTO)

After all wiring to the genset unit has been connected and system setting parameters have been checked and verified as correct the user should perform an initial operation test in both MANU and AUTO modes. Ensure that all wiring and controller settings match the Genset control and protection requirements.

### 5.3.1 Items to Check

1. Emergency Stop function
2. Overspeed Protection function
3. Over Temperature Protection function
4. Low Oil Pressure Protection function
5. All display screens

### 5.3.2 Start Procedure

When mode selector is placed to MANU the starter motor will immediately start cranking. The start procedure will proceed according to cranking time setting → cranking interval setting → repeat start attempts setting, until one of the conditions below occurs.

- Engine oil pressure is established
- AC Voltage is established
- AC Frequency is greater than 18 Hz

### 5.3.3 Shut Down Procedure

Place the Mode Selector to OFF position and the engine should immediately shutdown.

### 5.3.4 AUTO Mode Initial Operation Test

With the Remote Start contacts open place the Mode Selector to AUTO. Short the Remote Start contacts and the start procedure should commence (see 5.3.2) Open the contacts and the shutdown procedure should commence, with a cool down period before stopping.



## SECTION 6 : REMOTE OPERATION

### 6.1 Overview of Remote Monitoring and Control Functions

The following functions can be carried out through the GenOnCall® Remote APP

- View all genset real time operating information
- Receive push notification of all fault warnings, engine start / stop, security alerts and maintenance reminders.
- Obtain genset location information
- Review Event Log to assist in remote diagnosis of faults
- Execute remote genset start and stop operations (Operator authority only)
- Edit system parameters (Operator authority only)
- Erase Event Log and Reset Engine Running Hours (Owner authority only)

#### 6.1.1 Three Options for GC4K-E Internet Connection

The GC4K-E controller provides options of Wi-Fi, Dynamic IP network, and 3G/4G Wi-Fi router connections to the Internet. Refer to the comparison table below :

Connection Option	Connection Cost	Connection quality	Connection method	Applicable Environment	Installation and Setting Methods	Relevant Section in Manual
Wi-Fi network	Low	Good	Wireless	Any place with WiFi signal coverage	Possibly need to enter a WiFi password	6.2.1
Dynamic IP connection	Medium	Excellent	Wire (RJ45)	Locations with ADSL or fiber optic cable installed	Automatically acquires IP address	6.2.2
3G/4G wireless router (hot spot)	High	Good	Wireless	No WiFi or ADSL but has 3G/4G signal coverage	Possibly need to enter a WiFi password	6.2.3

#### NOTICE

1. Networks with unstable or low signal strength may frequently cause the controller and server to disconnect, interrupting remote monitoring functions. Users should take into account the environment where the unit is installed and select a stable network communication interface to provide stable data transmission.
2. GC4K-E remote monitoring functions are provided for no charge by the manufacturer. If a network connection is lost for any reason and remote monitoring or control cannot be carried out, the user has no right to demand the manufacturer pay any damages or assume any liability.

## 6.2 Controller Connection to Kutai Server



GC4K controller



Kutai Server

Mobile device

1. User verification and data security
2. Interconnection between devices

### 6.2.1 Wi-Fi Connection Settings

Select desired network and enter password to establish WiFi connection

Press  ► Press *System Setting* ► Press *WiFi Setting* ► Turn ON WiFi  ► The controller will automatically list the name and signal strength of all WiFi networks in the surrounding area ► Click on the name of the Wi-Fi network for connection ► Use the keypad to input WiFi password ► Press  to enter password.

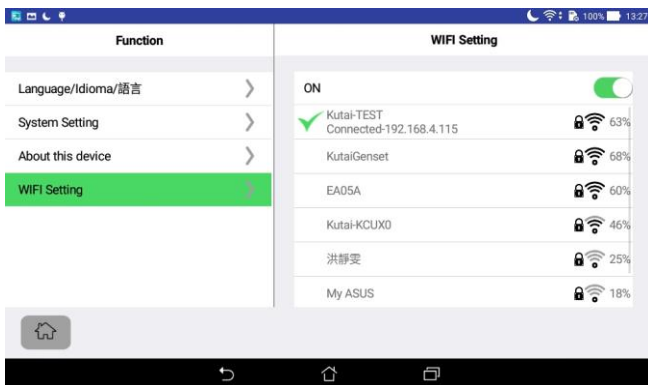

#### Wi-Fi connection successful screen

When the control unit is successfully connected to a Wi-Fi network a check mark will appear in front of the network name. Press  to the Home page.

When a controller is connected the Connected icon  will appear in the Status bar.

### 6.2.2 Dynamic IP Connection (Ethernet)

To use a dynamic IP connection first confirm that the RJ45 connector is securely installed on the controller and that any fire wall function must be turned OFF. The controller will automatically obtain an IP address and connect to the Kutai Server. The Controller cannot obtain an IP Address from a Static IP network. An IP router must be added to provide a Dynamic IP address for the controller to connect to.

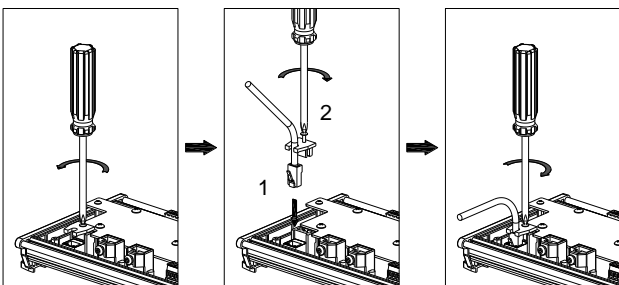

Attach the RJ45 network connector in accordance with the images to the left. Improper installation could lead to a loose connection from vibration causing the controller to disconnect from the Internet. When a connection is established  will appear in the status bar.

### 6.2.3 3G / 4G Wireless Router Installation

When a genset is installed in a location without Wi-Fi or Ethernet connections it will be necessary to install a mobile WiFi router. See Section 6.2.1 for settings.

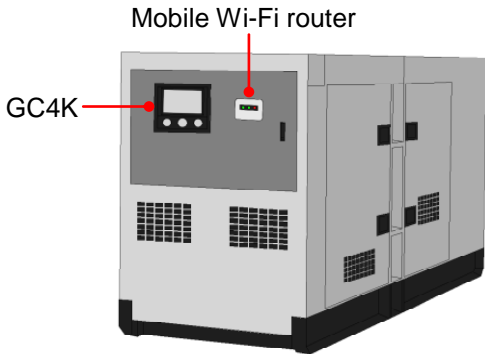

Select a 3G/4G mobile Wi-Fi router suitable for the frequency bands supplied by local wireless carriers. Contact local 3G/4G data service providers for assistance.

1. To avoid shielding the signal do not install inside genset canopy.
2. Pay particular attention to protection from vibration and water entry when installed outdoors.

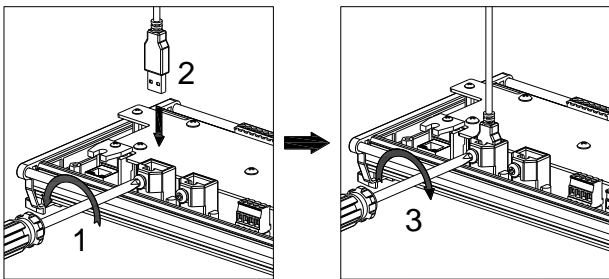

Power for the mobile Wi-Fi router is provided by the GC4K-E. Connect as shown in the drawing on the left.

### 6.3 Mobile Connection to GCU-4K

All Owners, Operators, and Viewers using remote monitoring are required to apply for a personal account on the Kutai Server and follow the procedures below to connect to the controller with GenOnCall<sup>®</sup> Remote App.

#### 1. Owner connection procedure

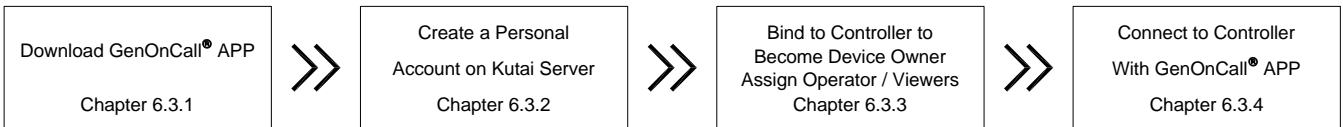

#### 2. Operator and Viewers connection procedure



### 6.3.1 GenOnCall® App Download 📱

There are three versions of the GenOnCall APP to match the User mobile device operating system and the region where the unit operates, which a User can download from the following sites.

1. Apple iOS (global) : Go to the Apple Store and download the GenOnCall.APP
2. Android (outside mainland China) : Go to Google Play store and download the GenOnCall.APP
3. Android (mainland China) : Go to Mi Store and download the GenOnCall\_CN.APP

#### NOTICE







1. GenOnCall.APP does not support the mainland China Android operating system. For the mainland China Android operating system users should download the GenOnCall\_CN.APP
2. In China mainland region the Push Notification function depends on the quality of the telecommunications service and may experience delays or fail to deliver in some situations. Push Notification function reliability cannot be assured.

### 6.3.2 Create a Personal Account on The Kutai Server

A personal connection account can be made in any of the following ways.

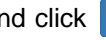
1. Apply through the “My Account” page on the Kutai website (Section 6.3.2.1)
2. Apply through the iOS GenOnCall® APP (Section 6.3.2.2)
3. Apply through the Android GenOnCall® APP (Section 6.3.2.3)





#### 6.3.2.1 Create an Account on The Kutai Website

Go to the Kutai website [www.kutai.com.tw](http://www.kutai.com.tw) ▶ Click  on the Kutai home page ▶ Click on [CREATE AN ACCOUNT](#) ▶ Read the *Terms of Services* carefully, then enter the Captcha  and press  ▶ Fill in the user name, email account and password, enter the Captcha  and click  ▶ Log-in to the email account entered to copy the four digit authentication code sent by the server ▶ In the Kutai Account Management System page enter the account name and password, enter the Captcha  and click  ▶ enter the four digit authentication code from the email and click  The account application procedure is complete.







#### NOTICE

1. The system will automatically send a four digit authentication code to the email address entered so it must be a valid email address.
2. The user should complete the account opening process within 30 minutes. If the four-digit authentication code expires the user must go through the application process again.
3. The letters in Captcha images are not case sensitive.

#### 6.3.2.2 Create an Account Using The iOS GenOnCall® APP 📱

Open GenOnCall® APP ▶ Click on  ▶ Read the *Terms of Services* carefully then press  ▶ Fill in User name, email account and password, and click  ▶ Log-in to the email account entered and read the four digit authentication code sent by the server ▶ Enter the account number and password in the login screen and click  ▶ enter the four digit authentication code and click  The account application procedure is complete.

#### 6.3.2.3 Create an Account Using The Android GenOnCall® APP 📱



Open GenOnCall® APP ▶ Click on  ▶ Read the *Terms of Services* carefully, then enter the Captcha  and press  ▶ Fill in the user name, email account and password, then enter the Captcha  and click  ▶ Log-in to the email address entered and copy the four digit authentication code sent by the server ▶ Enter the email account and password in the login screen and click  ▶ enter the four digit authentication code and click  The account application procedure is complete.

### 6.3.3 Bind The Controller and Edit Operator and Viewers

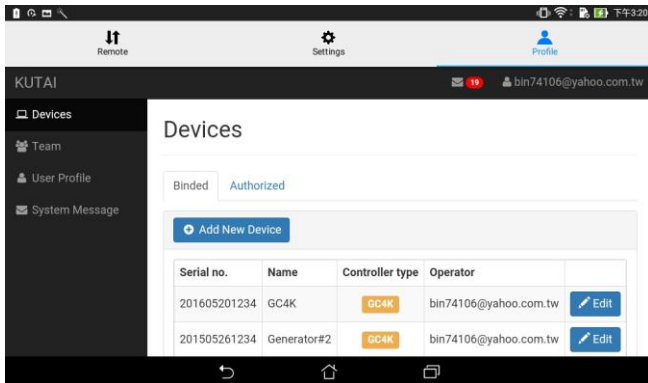
Before any GC4K-E controller can be remotely monitored and controlled it must first be bound to an owner through the binding procedure. The owner can then assign operator or viewer status to other accounts registered on the Kutai server. The Kutai server will reject connections to controllers that have not been bound to an owner or from accounts without operator or Viewers authority.



#### Step 1

Log-in with the GenOnCall® APP. Press  to enter the devices screen. Press  to open up a Device Serial no. input box.

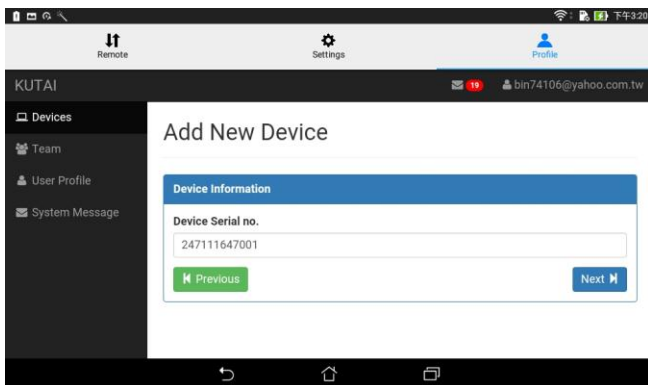

#### Step 2

Fill-in the serial number of the device to be binded. Press  to enter the device Information screen.

1. When binding a controller it must be connected to the Kutai Server. If the controller is not connected to the Internet or the wrong serial number is entered the system will show “Device OFF Line” message.
2. If the controller is already bound to another owner the screen will display a message “Device Already Bound”.

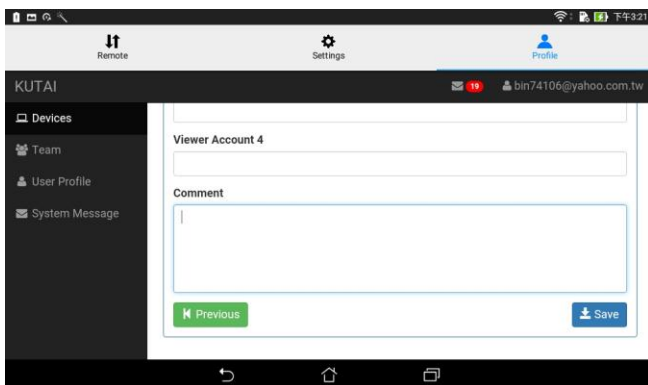

#### Step 3

Edit the device Name, assign operator and viewer authority status. Press  and bak to device page automatically.

A controller allows only one operator and up to seven viewers. The account that logs on to the bind the unit will become the owner and will have both operator and viewer authority at the same time.

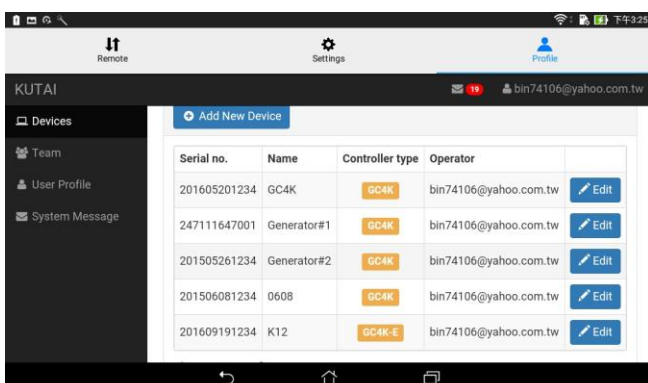

#### Step 4



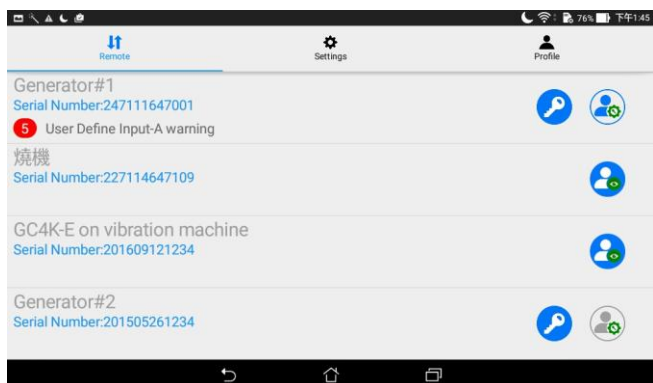

View details of binded devices the screen will add the newly bound device after saving.

### 6.3.4 Establishing Connection With a Controller

After all steps are in 6.3.3 are completed a user can open the GenOnCall<sup>®</sup> remote APP on a mobile device to establish the connection with the controller.



Select the controller to be connected and click on the connect button to the right to establish a connection.  
Explanation of symbols :

-  : Operator connection button
-  : Viewer connection button
-  : Grey color indicates that the controller is off line.
-  : Owner of the device



Operator log-on screen

The AUTO / OFF / MANU buttons will only be displayed when logged on as the operator.

### 6.3.5 Unbinding a Device

Once a controller is bound to an owner, it cannot be bound by another account unless the unbinding procedure is carried out first.

Place Mode Selector to OFF ► Press and hold the owner SW for two seconds ► Select *Unbind Device* ► Press **ENTER** to carry out Unbind device procedure.



Unbinding screen





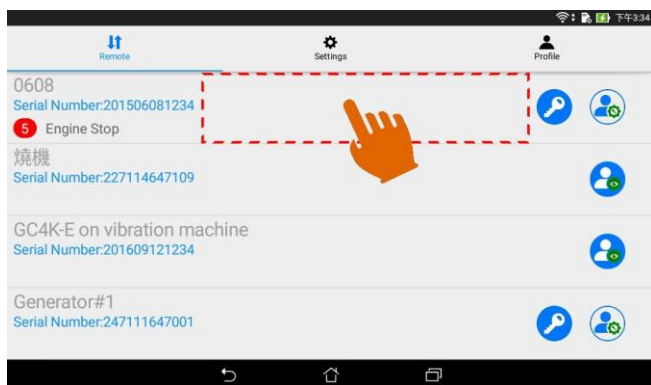

## 6.3.6 GenOnCall® Remote : Log-in to Advanced Settings Screen

### 6.3.6.1 Push Notification Editor

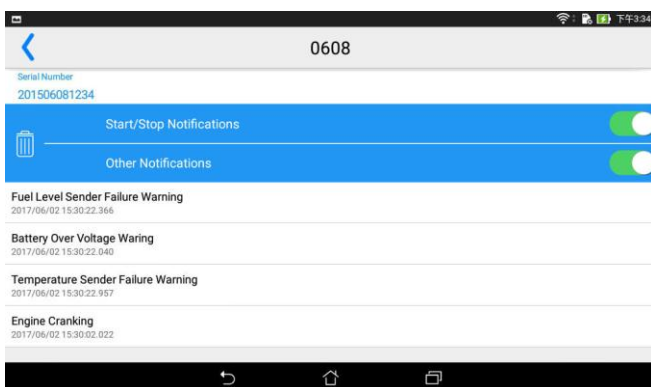



In the “Remote” screen click on the blank area of the desired controller to directly enter the Push Notification recorder page.

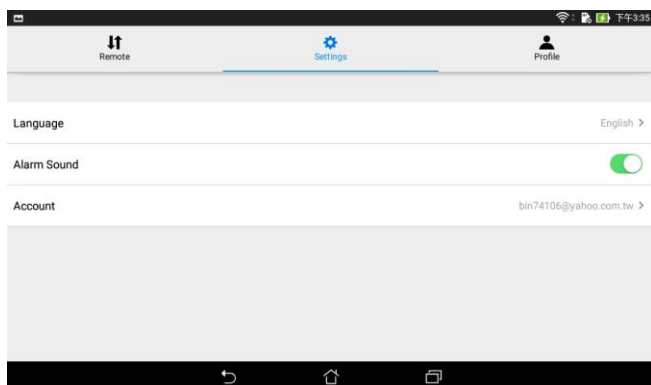

1. Clicking  can delete all “Push Notification” at one time.
2. Clicking  turns ON or OFF the *Start/Stop Notification*
3. Clicking  turns ON or OFF *Other Notifications*.
4. To delete an individual message just quickly swipe left on the notification.

### 6.3.6.2 Overview of Settings Options



Pressing  to enter the setting screen the user can select following options on the mobile device :

1. Select English, Traditional Chinese, or Spanish as the display language of the mobile device.
2. Turn audio alarm ON/OFF by clicking Alarm Sound .
3. Log-out of User account.

### 6.3.6.3 Overview of Profile Options

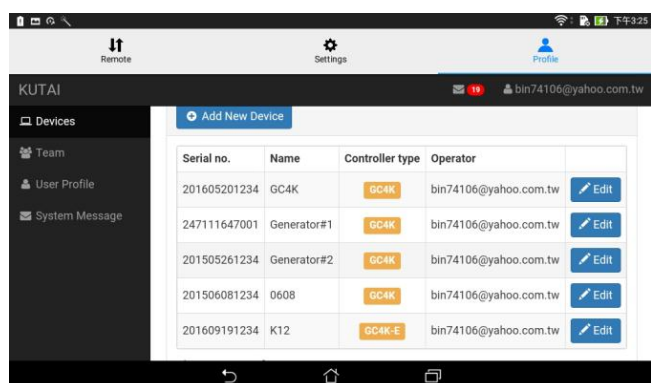

Profile Main Screen

In the Profile screen a user can set the following items :

1. Devices : list all bound and authorized devices.
2. Team : List of all other accounts that have ever been authorized by this account.
3. User Profile : Edit individual information and password.
4. System Message : Record of all controllers that have ever been bound or been authorized.



## SECTION 7 : GCU-4K INTRODUCTION

### 7.1 Product Overview

The GCU-4K control module provides complete protection for generator sets, remote monitoring, location information of the unit and push notification. The user can perform remote settings directly from the touch screen display or through the GenOnCall® remote monitoring APP to set control and protections required by the unit. Applicable to almost all generator sets that require remote control and protection.

### 7.2 Features

- 7-inch IPS display panel with resolution 1280×800 and front panel meets IP65
- User-friendly, intuitive touch-screen interface to input all settings
- Integrated, modular design control panel with Mode Selector Switch, Emergency Stop Button, and Audio / Voice Speaker
- Digital and Analog gauge displays for all electrical parameters
- Wi-Fi, 3G/4G Mobile Router and physical Ethernet network connections
- Free iOS and Android GenOnCall® APP download enables remote operation, monitoring and configuration for smart phone or tablet
- Choice of Chinese, English, Spanish language display
- Engine Start Voice Warning broadcast in ten most common languages – also allows for user recorded engine start voice warnings
- Free online updates of controller firmware and GenOnCall® APPs
- Provides generator location services (GPS)
- Push notification for Engine Start / Stop and Fault Alarms – records up to 250 events
- Real-time graphic display of AC current and voltage curves
- Transfer Settings function (dump function) eliminates need to program each controller individually
- Displays up to 53 electronic engine control ECU (SAE J1939) parameters
- Transfer Settings function (dump function) for production line use – eliminates need to program each controller individually
- Supports Modbus / SNMP / RS-485 protocols (optional modules)
- Battery power removed and Genset position Shifted alarm for theft alert
- Allows for one Operator and up to seven Viewers to connect simultaneously for remote monitoring and control
- Two user-defined outputs/inputs for control or protection

### 7.3 Displayed Parameter

- AC power parameters – V(RMS), A(RMS), Hz, KW, KWH, KVA, KVAR & PF

- Displays electronic engine control unit ECU (SAE J1939) parameters
- Operating Hours / Maintenance Hours / DC Battery Voltage
- Operating Temperature (°C or °F), Oil Pressure (PSI or Bar) and Fuel Level (%)
- Real-time graphic displays of current and voltage power quality
- Records up to 250 events – Engine Start / Stop and all Fault Alarms
- Genset GPS location map (only on remote monitoring APP)

### 7.4 Monitoring and Protections

- Full phase Over Voltage / Under Voltage and lost phase
- Current overload
- High Coolant Temperature
- Low Oil Pressure
- Engine Over Speed / Under Speed protection
- Low Fuel Level
- Charging Alternator failure
- Battery abnormal alarm
- Scheduled Maintenance notification
- Emergency Stop alarm
- ECU (SAE J1939) Communication Failure
- Wi-Fi signal strength too low warning
- User-defined input

#### NOTICE

**When battery power is removed or the generator is shifted from existing orientation the GCU-4K control unit will automatically send an alarm message. The user will be made aware that the generator is being damaged or stolen.**

### 7.5 Electrical Characteristics

DC power input	9 – 40 Vdc
AC power input	15 – 500 Vac (Phase to Phase)
AC power frequency	50/60 Hz
Engine start signal output	10 Amp @ 12/24 Vdc
Engine stop signal output	10 Amp @ 12/24 Vdc
Preheat signal output	2.5 Amp @ 12/24 Vdc
Screen lighting signal output	2.5 Amp @ 12/24 Vdc
Fault alarm signal output	2.5 Amp @ 12/24 Vdc
Overload trip signal output	2.5 Amp @ 12/24 Vdc
IDLE control signal output	2.5 Amp @ 12/24 Vdc
Operating Temperature	-20 to +60 °C
Relative humidity	Max. 95%
Static power consumption	less than 7W
Rated burden	greater than 2.5VA
CT secondary current	1A / 5A

---

## SECTION 8 : SOFTWARE AND FIRMWARE UPDATES

Based on functional requirements Kutai Electronics will provide updates to the GC4K-E control firmware and GenOnCall® APPs from time to time. An update icon  will display for quick download whenever the controller or a mobile device is connected to the Internet and there are new updates.

### NOTICE

**To ensure that the controller and mobile device operating optimally the user should connect the controller and mobile devices to the internet on a regular basis to check whether or not there are any new updates.**

## SECTION 9 : OPTIONAL ACCESSORIES

1. ModBus communication module (KCU-05). For installation instructions refer to the KCU-05 User Manual.
2. SNMP communication module (KCU-06). For installation instruction refer to the KCU-06 User Manual.